

# Quick Start Guide

INSTEON® Micro On/Off

Models: 2443-222, 2443-422, 2443-522

## Tools Needed

- Slotted #1 screwdriver
- Philips screwdriver
- Voltage meter
- Wire cutter/stripper

## Installing Micro Module

Installation should only be performed by a qualified electrician or a homeowner who is familiar and comfortable with electrical circuitry. If you have questions, consult an electrician or call the INSTEON Support Line at 866-243-8022

- 1) Write down the INSTEON ID found on the back of the unit (XX.XX.XX)
- 2) Turn off breaker/fuse and verify that the power is off
- 3) Disconnect wires from existing switch, fixture or outlet and prep all wires to be connected to Micro module, with 3/16" (5mm) of bare wire on the ends
- 4) Connect wires per diagram which corresponds to your installation

Note: sense lines carry very low current (~0.35mA 240V, ~0.17mA for 120V)

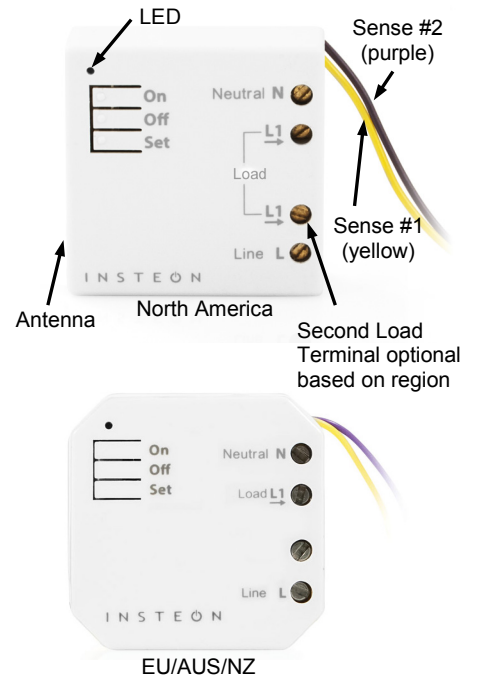

Without Switch

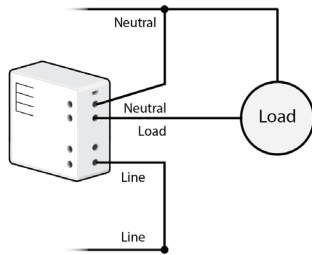

Note: cap the unused sense wires

Latching

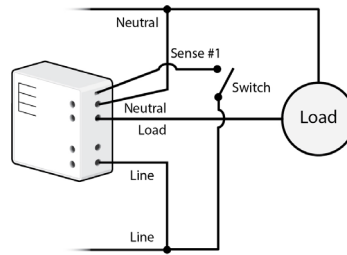

Note: cap the unused Sense #2 wire

Single Momentary

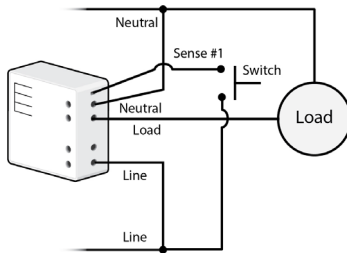

Note: cap the unused Sense #2 wire

Dual Momentary

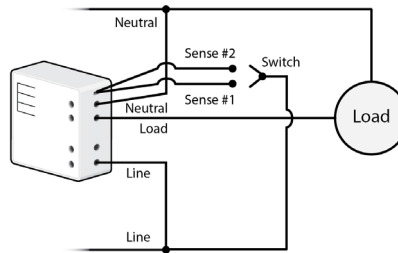

- 5) After ensuring wires are firmly connected and that there is no exposed wire, turn on breaker/fuse  
*After a few seconds, load will turn on (if wired into switch or fixture) and Micro module LED will turn green*
- 6) Test by tapping Micro module on/off buttons  
*Load will turn on and off*  
*Micro Module LED will turn green when load is on and red when load is off*
- 7) If installing a single momentary or dual momentary switch
  - a) Press and hold set button until it beeps  
*LED will start blinking green*
  - b) Press and hold set button until it beeps a second time  
*LED will start blinking red*
  - c) Press and hold set button until it beeps a third time  
*LED will start blinking green*

- d) Perform the step that applies
  - For single momentary: slowly tap set button four times  
*LED will continue blinking green*
  - For dual momentary: slowly tap set button five times  
*LED will start double-blinking green*
  - To switch back to latching: slowly tap set button six times  
*LED will start blinking green*
- e) Once the mode is selected, press and hold set button until it double-beeps  
*LED will stop blinking and turn green if load is on or red if load is off*

### Make Micro Module a Responder

Control Micro module from another INSTEON device.

Perform before finalizing installation of the switch, fixture or outlet. Or refer to the manual if already installed.

- 1) Press and hold controller button until it beeps  
*Controller LED will start blinking*
- 2) Tap Micro module on (or off if you want the load to turn off when the scene is activated)  
*Connected load will respond appropriately*
- 3) Press and hold Micro module set button until it double-beeps  
*Controller will double-beep and its LED will stop blinking*
- 4) Test by tapping controller button on and off  
*Connected load will return to the state set in step #2*

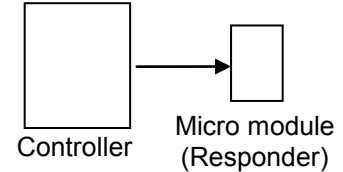

### Make Micro Module a Controller

Use Micro module to control other INSTEON devices.

Perform before finalizing installation of the switch, fixture or outlet. Or refer to the manual if already installed.

- 1) Press and hold Micro module set button until it beeps  
*Micro module LED will start blinking green*
- 2) Turn responder on (or any other state such as on 50% or even off)
- 3) Press and hold responder set button until it double-beeps  
*Micro module will double-beep and its LED will stop blinking*
- 4) Test by tapping Micro module on/off buttons  
*Responder load will respond appropriately*  
*Micro module LED will turn green when load is on and red when load is off*

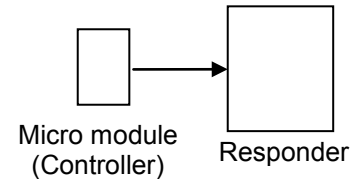

### Assign an X10 Address

- 1) Press and hold Micro module set button until it beeps  
*Micro module LED will start blinking green*
- 2) Send the X10 address 3 times (with or without commands)  
*Example: A1-A1-A1-AON or A1-AON-A1-AON-A1-AON*  
*Micro module will double-beep and its LED will stop blinking*
- 3) Test by sending X10 on and off commands  
*Load will turn on and off*

### Owner's Manual and Tech Support

Visit: <http://www.insteon.com/support> for complete manual, online tech support and latest product documents.

Call: INSTEON Support Line at 866-243-8022

### FCC and IC Warnings

This device complies with FCC Rules and Industry Canada license-exempt RSS standard(s). Operation is subject to the following two conditions: (1) this device may not cause harmful interference, and (2) this device must accept any interference, including interference that may cause undesired operation of the device.

Le présent appareil est conforme aux CNR d'Industrie Canada applicables aux appareils radio exempts de licence. L'exploitation est autorisée aux deux conditions suivantes: (1) l'appareil ne doit pas produire de brouillage, et (2) l'utilisateur de l'appareil doit accepter tout brouillage radioélectrique subi, même si le brouillage est susceptible d'en compromettre le fonctionnement.

CAUTION - To reduce the risk of overheating and possible damage to other equipment do not install to control a receptacle, a motor-operated appliance, a fluorescent lighting fixture, or a transformer-supplied appliance.

Gradateurs commandant une lampe à filament de tungstène – afin de réduire le risque de surchauffe et la possibilité d'endommagement à d'autres matériels, ne pas installer pour commander une prise, un appareil à moteur, une lampe fluorescente ou un appareil alimenté par un transformateur.