

Quick Start Guide

INSTEON® DIN Rail On/Off

Models: 2453-222, 2453-422, 2453-522

Tools Needed

- Slotted #1 screwdriver
- Voltage meter
- Wire cutter/stripper

Installing INSTEON DIN Rail

Installation should only be performed by a qualified electrician or a homeowner who is familiar and comfortable with electrical circuitry. If you have questions, consult an electrician or call the INSTEON Support Line at 866-243-8022

- 1) Turn off breaker/fuse and verify that the power is off
- 2) Disconnect wires from existing switch, fixture or outlet and prep all wires to be connected to DIN rail, with 5/16" (8mm) of bare wire on the ends
- 3) Snap module onto DIN rail
- 4) Connect wires per diagram which corresponds to your installation

Note: sense lines carry very low current (~0.35mA 240V, ~0.17mA for 120V)

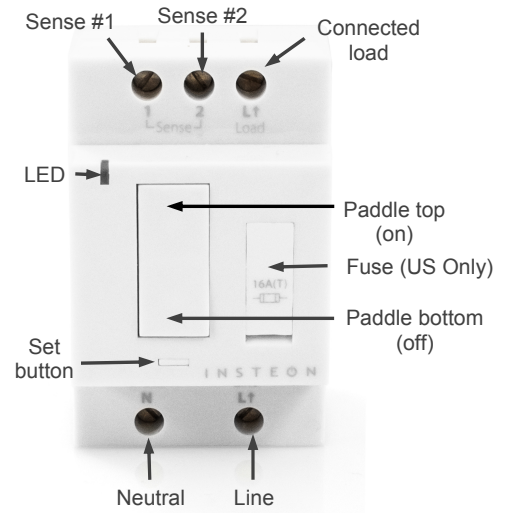

Without Switch

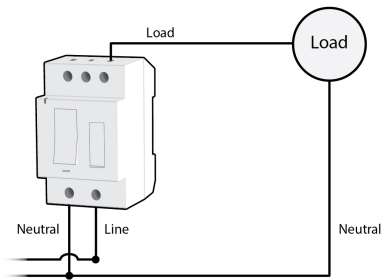

Latching

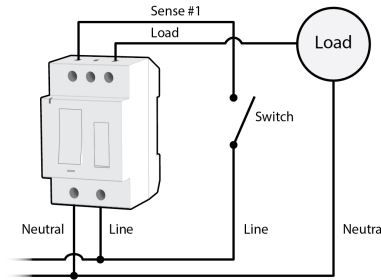

Single Momentary

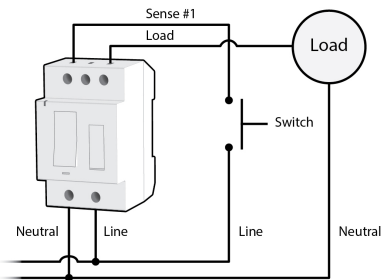

Dual Momentary

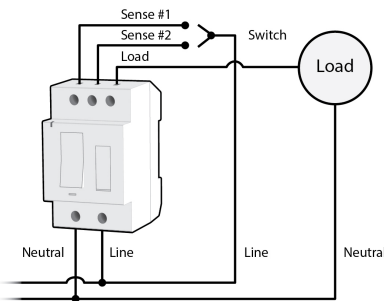

- 5) After ensuring wires are firmly connected and that there is no exposed wire, turn on breaker/fuse
After a few seconds, load will turn on and DIN Rail LED will turn green
- 6) Test by tapping DIN Rail paddle top and bottom
Load will turn on and off
Din Rail LED will turn green when load is on and red when load is off
- 7) If installing a single momentary or dual momentary switch
 - a) Press and hold set button until it beeps
LED will start blinking green
 - b) Press and hold set button until it beeps a second time
LED will start blinking red
 - c) Press and hold set button until it beeps a third time
LED will start blinking green

- d) Perform the step that applies
 - For single momentary: slowly tap set button four times
LED will continue blinking green
 - For dual momentary: slowly tap set button five times
LED will start double-blinking green
 - To switch back to latching: slowly tap set button six times
LED will start blinking green
- e) Once the mode is selected, press and hold set button until it double-beeps
LED will stop blinking and turn green if load is on or red if load is off

Make DIN Rail a Responder

Control DIN Rail from another INSTEON device:

- 1) Press and hold controller button until it beeps
Controller LED will start blinking
- 2) Tap DIN Rail on (or off if you want the load to turn off when the scene is activated)
Connected load will respond appropriately
- 3) Press and hold DIN Rail set button until it double-beeps
Controller will double-beep and its LED will stop blinking
- 4) Test by tapping controller button on and off
Connected load will return to the state set in step #2

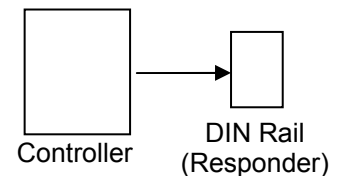

Make DIN Rail a Controller

Use DIN Rail to control other INSTEON devices:

- 1) Press and hold DIN Rail set button until it beeps
DIN Rail LED will start blinking green
- 2) Turn responder on (or any other state such as on 50% or even off)
- 3) Press and hold responder set button until it double-beeps
DIN Rail will double-beep and its LED will stop blinking
- 4) Test by tapping DIN Rail paddle top and bottom
Responder load will respond appropriately
Din Rail LED will turn green when load is on and red when load is off

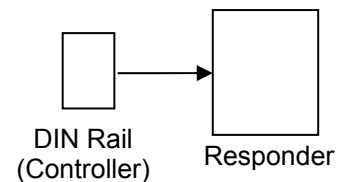

Assign an X10 Address

- 1) Press and hold DIN Rail set button until it beeps
DIN Rail LED will start blinking green
- 2) Send the X10 address 3 times (with or without commands)
Example: A1-A1-A1-AON or A1-AON-A1-AON-A1-AON
DIN Rail will double-beep and its LED will stop blinking
- 3) Test by sending X10 on and off commands
Load will turn on and off

Owner's Manual and Tech Support

Visit: <http://www.insteon.com/support> for complete manual, online tech support and latest product documents.

Call: INSTEON Support Line at 866-243-8022

FCC and IC Warnings

This device complies with FCC Rules and Industry Canada license-exempt RSS standard(s). Operation is subject to the following two conditions: (1) this device may not cause harmful interference, and (2) this device must accept any interference, including interference that may cause undesired operation of the device.
Le présent appareil est conforme aux CNR d'Industrie Canada applicables aux appareils radio exempts de licence. L'exploitation est autorisée aux deux conditions suivantes: (1) l'appareil ne doit pas produire de brouillage, et (2) l'utilisateur de l'appareil doit accepter tout brouillage radioélectrique subi, même si le brouillage est susceptible d'en compromettre le fonctionnement.

CAUTION - To reduce the risk of overheating and possible damage to other equipment do not install to control a receptacle, a motor-operated appliance, a fluorescent lighting fixture, or a transformer-supplied appliance.
Gradateurs commandant une lampe à filament de tungstène – afin de réduire le risque de surchauffe et la possibilité d'endommagement à d'autres matériels, ne pas installer pour commander une prise, un appareil à moteur, une lampe fluorescente ou un appareil alimenté par un transformateur.